

Product Specification

CL-AN404 controller



深圳市晨亮光电科技有限公司
Shenzhen Clen Optoelectronics Co., Ltd





Product name: 4ports led controller (External power)

Product mode: CL-AN404

Overview: Based on the ARTNET protocol Ethernet network driver, the controller can convert the network data packets in the ARTNET protocol into standard DMX512 data or SPI data. The controller has three control modes: ARTNET、DMX and sACN mode, which can perform effect recording and can be used offline; it supports SPI+485 remote transmission with a distance of up to 100 meters. This product can be widely used in stage performance lighting control system, stage performance, bar lighting and other occasions, and it is more convenient to use with our pixel tube;

Product picture:

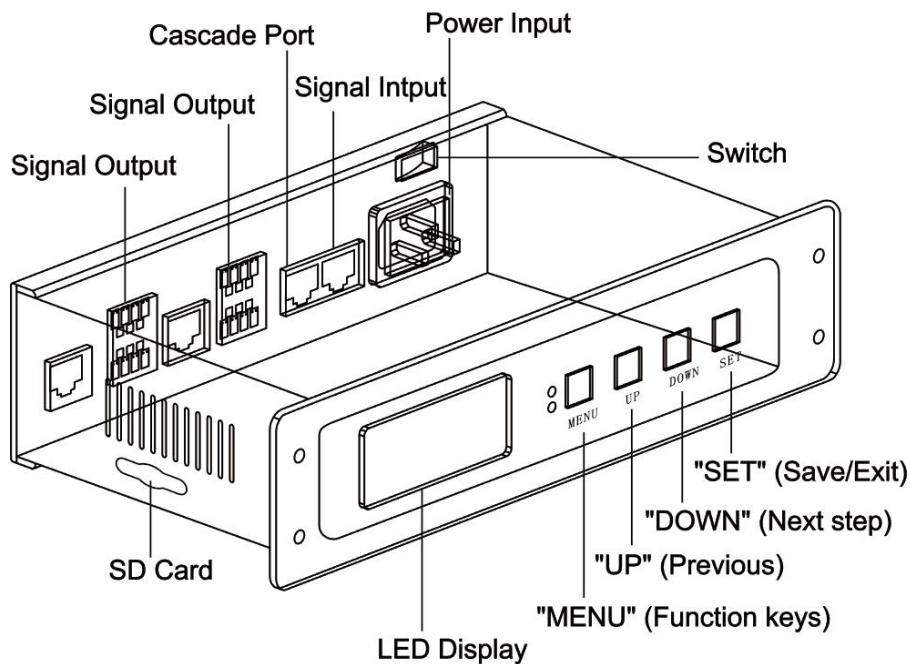



◆ **Product features:**

- Input Voltage: AC110—220V
- 4ports output,each port 680pixels;
- Three control modes, ARTNET、DMX and sACN mode;
- Support recording effect, it can record 31 different lighting effect, support offline control;
- External power supply,small size and easy to carry;

◆ **Parameter list**

Parameter	Unit	Min	Typical	Max
Working voltage(AC)	V	110	220	—
Power	W	—	—	10W
Output port	PCS	—	4	—
Port loading points	PIX	4*170	—	4*680
Control IC mode	—	—	WS2811/SK6812/UCS1903/UCS8903/UCS9812/ DMX512	—
Supporting software	—	—	MAD-SHOW (MADRIX/RESOLUME/MAD-MAPPER)	—
Control mode	—	—	ART-NET/DMX/sACN	—
Working mode	—	—	ART-NET/SD card	—
Controller IP address	—	—	2.0.0.X	—
Subnet mask	—	—	255.0.0.0	—
Computer IP address	—	—	2.0.0.2	—
Number of cascade units	PCS	—	—	64
Product weight	KG	—	0.6	—
Product size(L*W*H)	MM	—	228*126*55	—
Packing size(L*W*H)	MM	—	280*205*85	—
Product color	—	—	Matt silver+black	—
Product material	—	—	Aluminum	—



◆ Connection

① connect controller input port

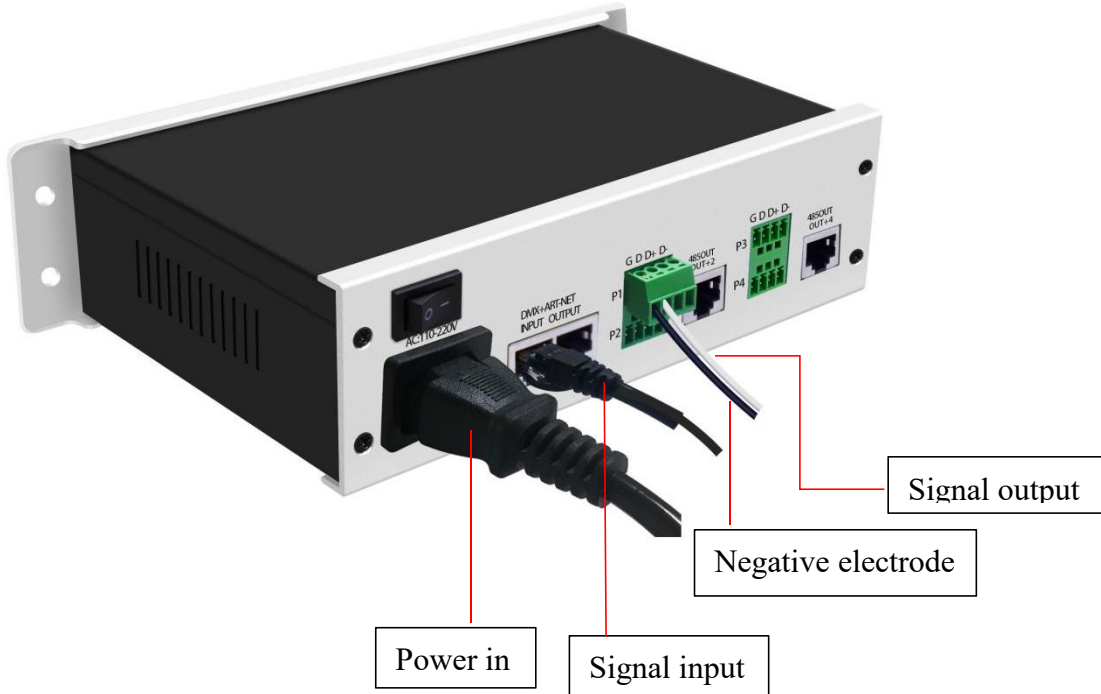

② Connect lamps

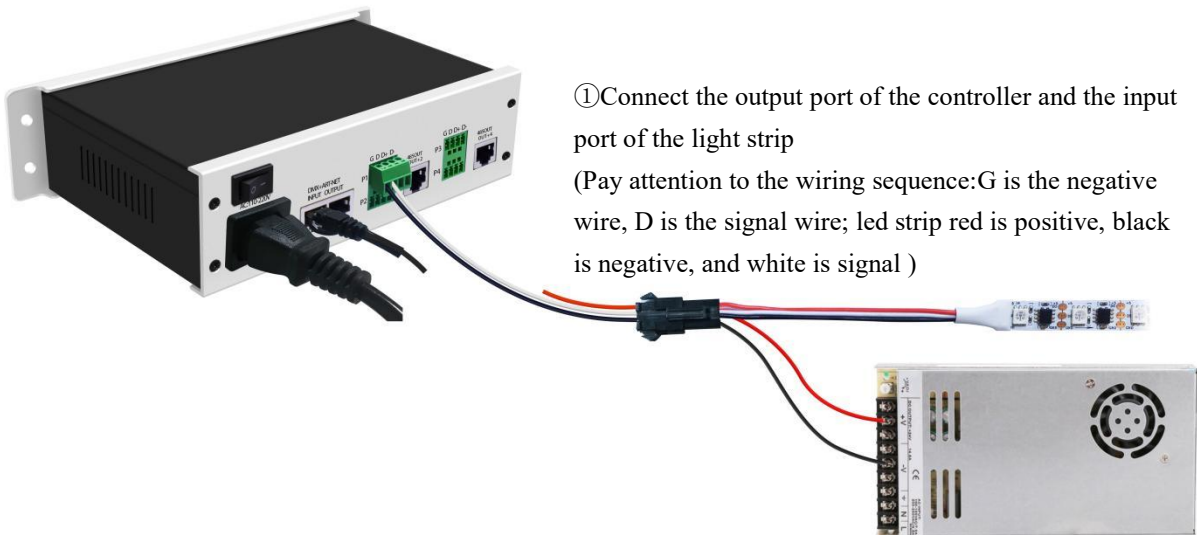

① Connect the output port of the controller and the input port of the light strip
(Pay attention to the wiring sequence: G is the negative wire, D is the signal wire; led strip red is positive, black is negative, and white is signal)

② External power supply to supply power to the light strip (red is positive and black is negative)



③ Console connect controller

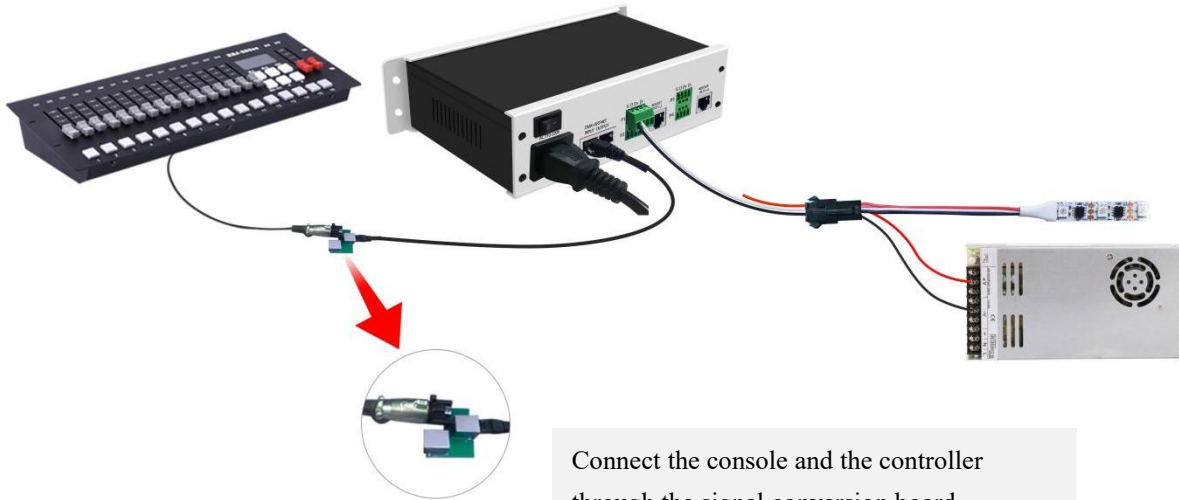

◆ Multiple units can be used in cascade



Note: When multiple controllers are cascaded, each controller IP setting cannot be the same! (Except for sACN mode)



◆ Control mode

ARTNET mode: ①After the controller is powered on, it enters the "ART-NET" mode by default, long press "MENU" for 3 seconds to enter the parameter setting, and click "UP" or "DOWN" to select the parameter that needs to be modified;

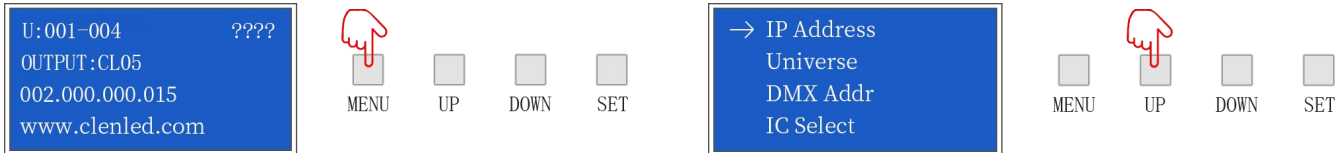

②Click "SET" to enter the parameter list to modify the parameters ("UP""DOWN" switch parameter values), click "SET" again to save, and long press "MENU" to return to the initial interface. The controller port output is an independent port output, one port maximum 680 pixels (IC UCS8903 has a maximum of 340 pixels).



SD card mode: ①After the controller is powered on, it enters the "ART-NET" mode by default, and simultaneously presses "UP" and "DOWN" for 3 seconds to enter the SD card mode;



②Click "UP" or "DOWN" to switch the built-in effects; click "MENU" or "SET" to switch the effect speed; total 31 built-in effects can be selected; long press "UP" and "DOWN" for 3 seconds to exit the SD card model.

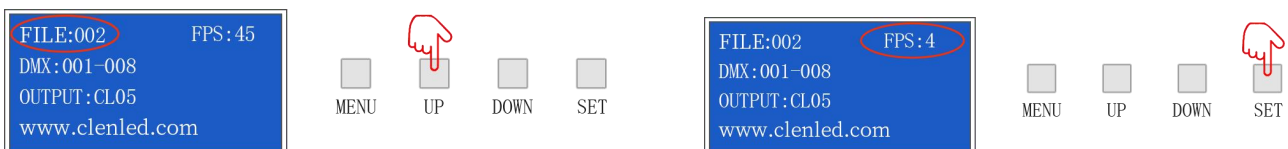



sACN mode: ①After the controller is powered on, it enters "ART-NET" mode by default. Press and hold MENU to enter the menu.

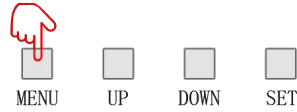

②Click "UP" or "DOWN" to switch options, select Mode Switch, click SET to enter the options, select sACN Mode, click SET and long press MENU to save the setting;

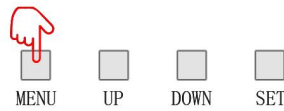
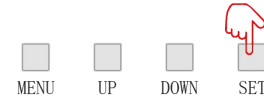
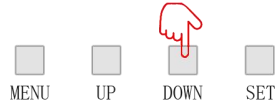

The sACN protocol is a lighting control protocol based on UDP. It uses Ethernet as the transmission medium. There is no need to set the IP address and it can be used immediately after connection; Take Madrix as an example. After connecting the computer and controller, there is no need to set the IP address to open it. Open Preferences-Options-Device Network Interface;

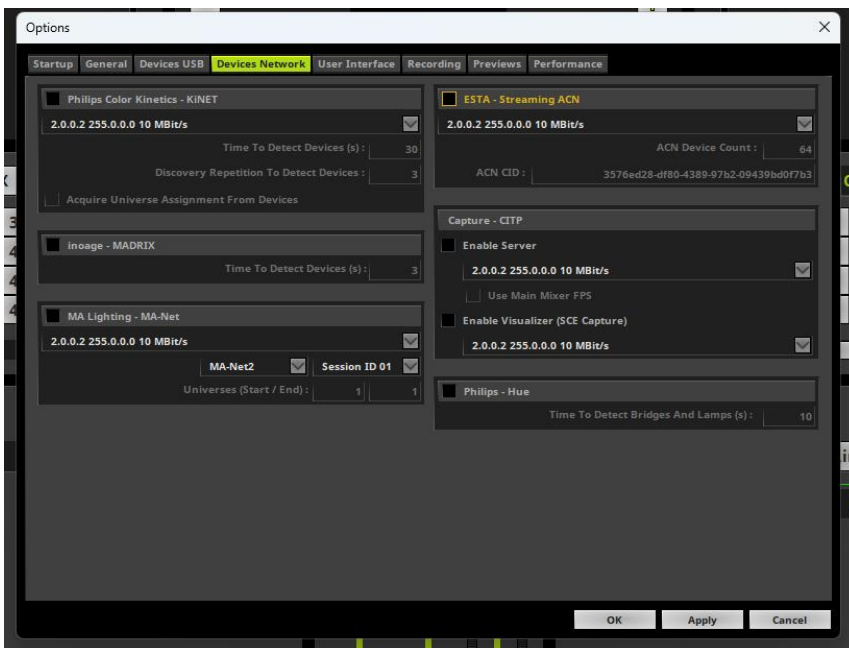



Turn on ESTA-Streaming ACN and select the IP address of the current computer;

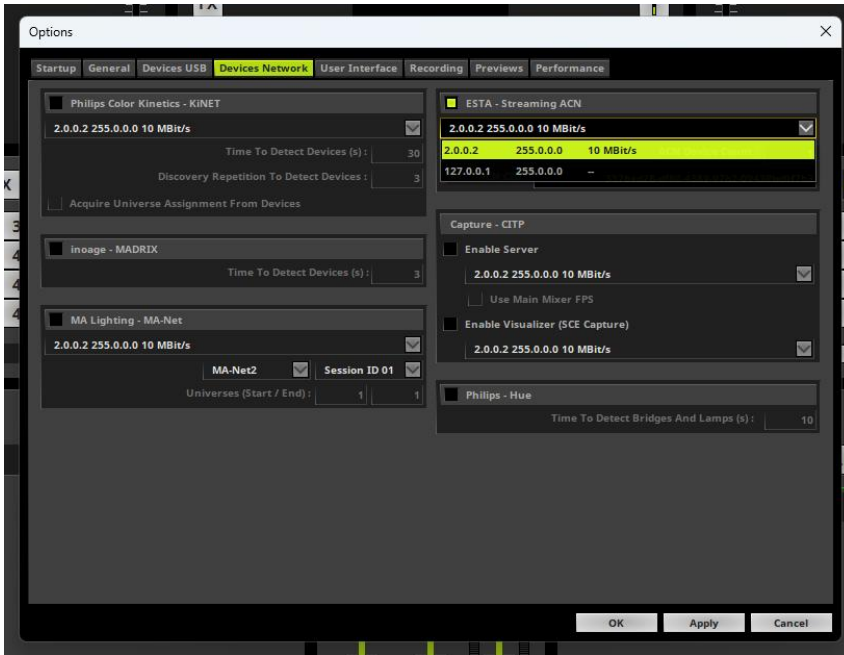

In the number of ACN devices, fill in the number of universe of the current controller and click the Apply button;

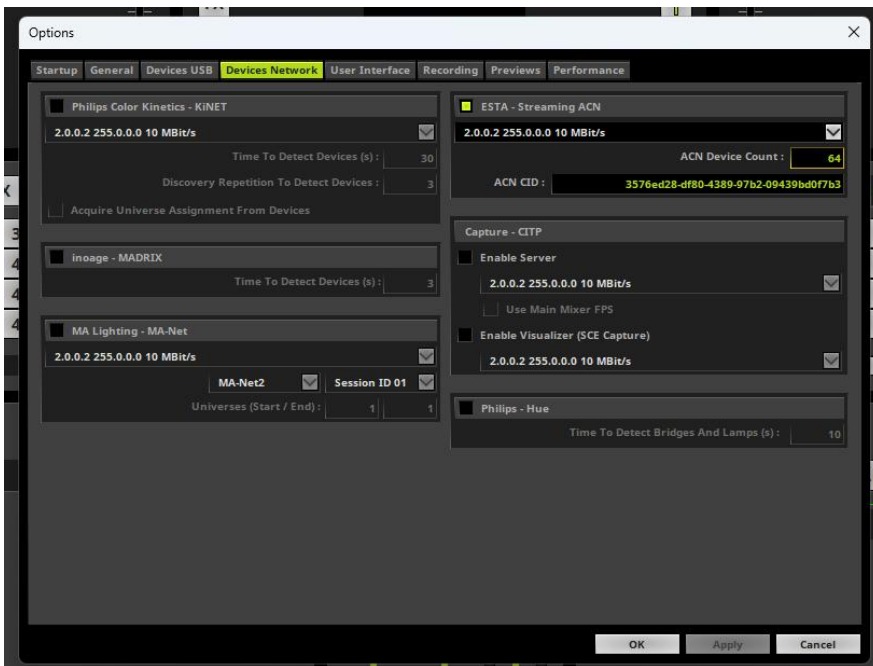



When we open the device manager list, we can see the list of connected universe;

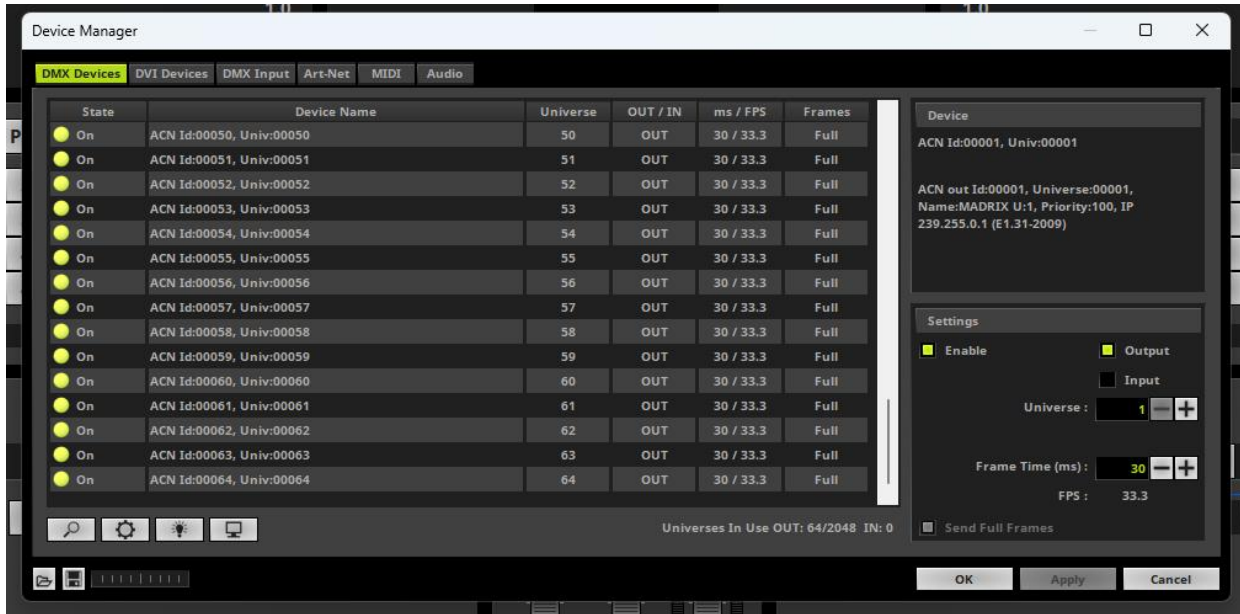

◆ DMX Channel Table Description

Channel	Name	Figure	Instructions
1	Mode selection	000-247	Call internal 31 effects (one effect for every 8 addresses, and 0-7 for SD card effect 1)
		248-255	Switch to ART_NET mode
2	Speed	000-255	0 is the slowest speed, 255 is the fastest speed, SD card mode is valid
3	Brightness	000-255	0 is the brightness off, 255 is the brightest, SD card mode is valid
4	R- mask	000-255	Subtract red from the effect. 000 is the original effect, and 255 means subtract all red from the effect
5	G-mask	000-255	Subtract green from the effect. 000 is the original effect, and 255 is subtracting all green from the effect
6	B-mask	000-255	Subtract the blue in the effect. 000 is the original effect. 255 means subtract all the blue in the effect
7	Invalid	000-007	



	Normally on	008-015	Constant bright white, color selection by mask (brightness, mask channel available)
	stroboscopic	016-255	The higher the value, the faster the strobe (speed, brightness, mask channel is effective)
8	Invalid	000-200	
	Record	201-255	When the value of channel 4.5.6 is 255, the recording is valid and the ART_NET effect is recorded to the file specified by channel 1

◆ Application

1. Stage performance;
2. The site of the product/press conference;
3. Concert lighting control;
4. Bar and KTV lighting control;

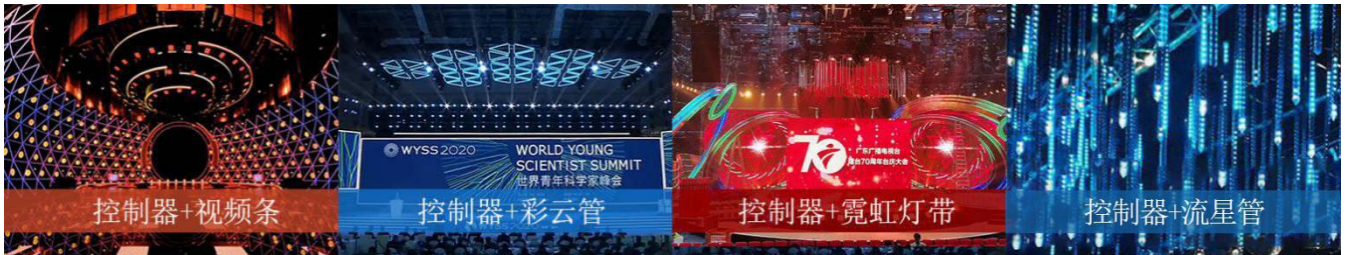

◆ Common problems

(1) Question: After the wiring is completed, the controller cannot be connected?

Answer: Check whether the wiring is correct and whether the plug is loose; In Art Net mode, check if the computer IP and subnet mask of the controller are consistent.

The corresponding computer IP and subnet mask are as follows:

IP:002.000.000.002 Subnet mask will be 255.000.000.000

IP:192.168.001.001 Subnet mask will be 255.255.255.000

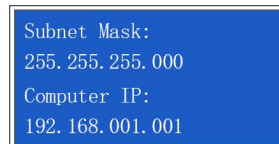
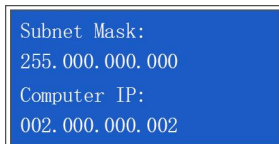



(2) Question: After connecting the controller, the light flashes quickly? (GND wire)

Answer: Check whether the GND wire of the controller terminal is loose.

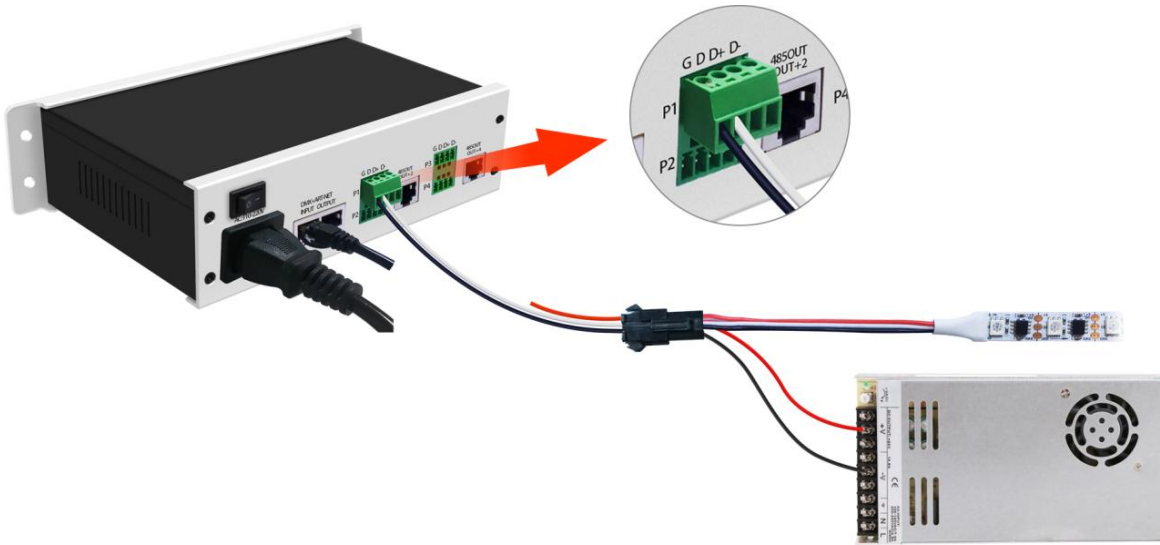

(3) Question: The controller is connected, but only the first lamp lights up? (Controller IC model setting)

Answer: Check if the controller IC settings are correct.

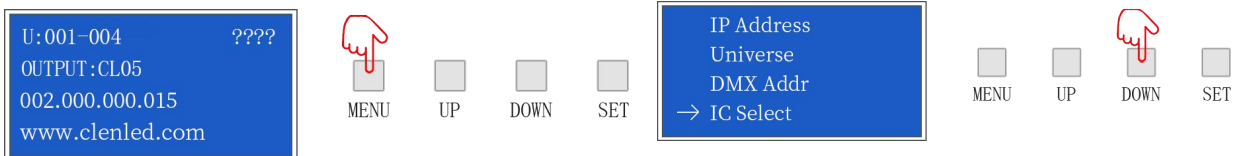

① long press "MENU" enter the parameter setting ② click "UP" or "DOWN" select IC module

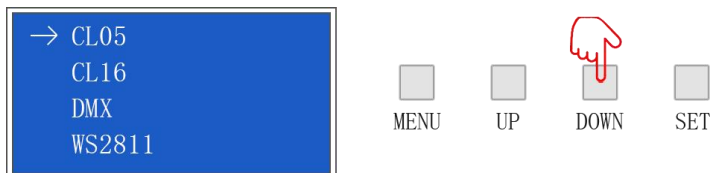

③ Click "SET" enter the parameter setting, press "UP" or "DOWN" choose the same IC with lampes



④ press "SET" to save the setting, check whether the lamp is work normally, long press "MENU" to return to the initial interface.



(4) Question: The lighting effect is inconsistent with the playback order?(Controller channel order setting)

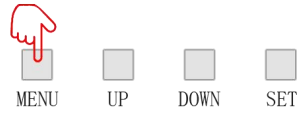

①long press“MENU”enter the parameter setting ②click“UP”or“DOWN”choose channel order

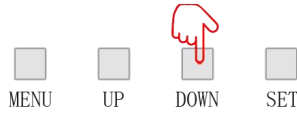

③click“SET”enter the parameter setting,press“UP”or“DOWN”choose the same channel order with lamps

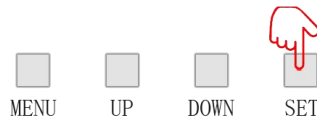

④click“SET”save setting,check whether the lamp is work normally, long press "MENU" to return to the initial interface.

Setting other parameters of the controller, please refer to the above steps

(5) Question: The front lamps are normal, but the brightness of the rear lamps is getting weaker and weaker? (Avoid pressure drop)

Answer: Pay attention to the voltage drop when low-voltage products are connected in series. If there is a voltage drop, the power supply to the tail of the lamp can be restored to normal.

(6) Question: After the controllers are cascaded in Art-Net mode, some controllers have no signal? (Controller Computer IP, Universe settings)

Answer: Check whether the wiring is correct and whether the plug is loose; check the computer IP (Computer IP) of each controller when the connection is correct. When multiple controllers are cascaded, the computer IP of each controller cannot;



After the controllers are cascaded, the playback effect of each controller is the same?

When multiple controllers are cascaded, each controller space (Universe) should be added, for example, the first one is 1-32, the second one is 33-64, and so on.

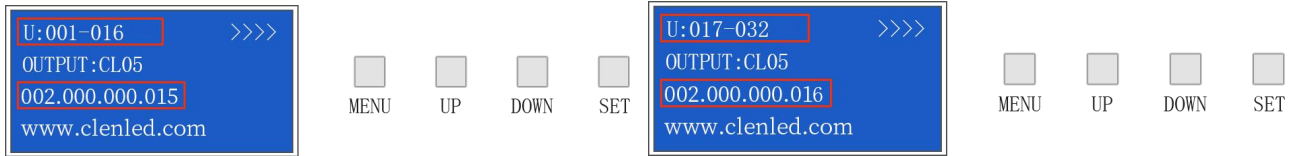

◆ **Attention**

1. Pay attention to the use environment and be waterproof and moisture-proof;
2. This controller needs an external power supply, please note that the output voltage of the power supply is consistent with the input voltage of the lamp;
3. Please follow the above instructions when connecting to an external power supply;
4. If any abnormality is found during use, contact us in time;