

Product Specification

AN804PRO Controller



深圳市晨亮光电科技有限公司
Shenzhen Clen Optoelectronics Co., Ltd





Product name: 8-port led controller (Need external power supply)

Product mode: AN804PRO

Overview: Based on the ARTNET protocol Ethernet network driver, the controller can convert the network data packets in the ARTNET protocol into standard DMX512 data or SPI data. The controller has three control modes: ARTNET、DMX and sACN mode, which can perform effect recording and can be used offline;it supports SPI+485 remote transmission with a distance of up to 200 meters. This product can be widely used in stage performance lighting control system, stage performance, bar lighting and other occasions, and it is more convenient to use with our pixel tube.

Product picture:

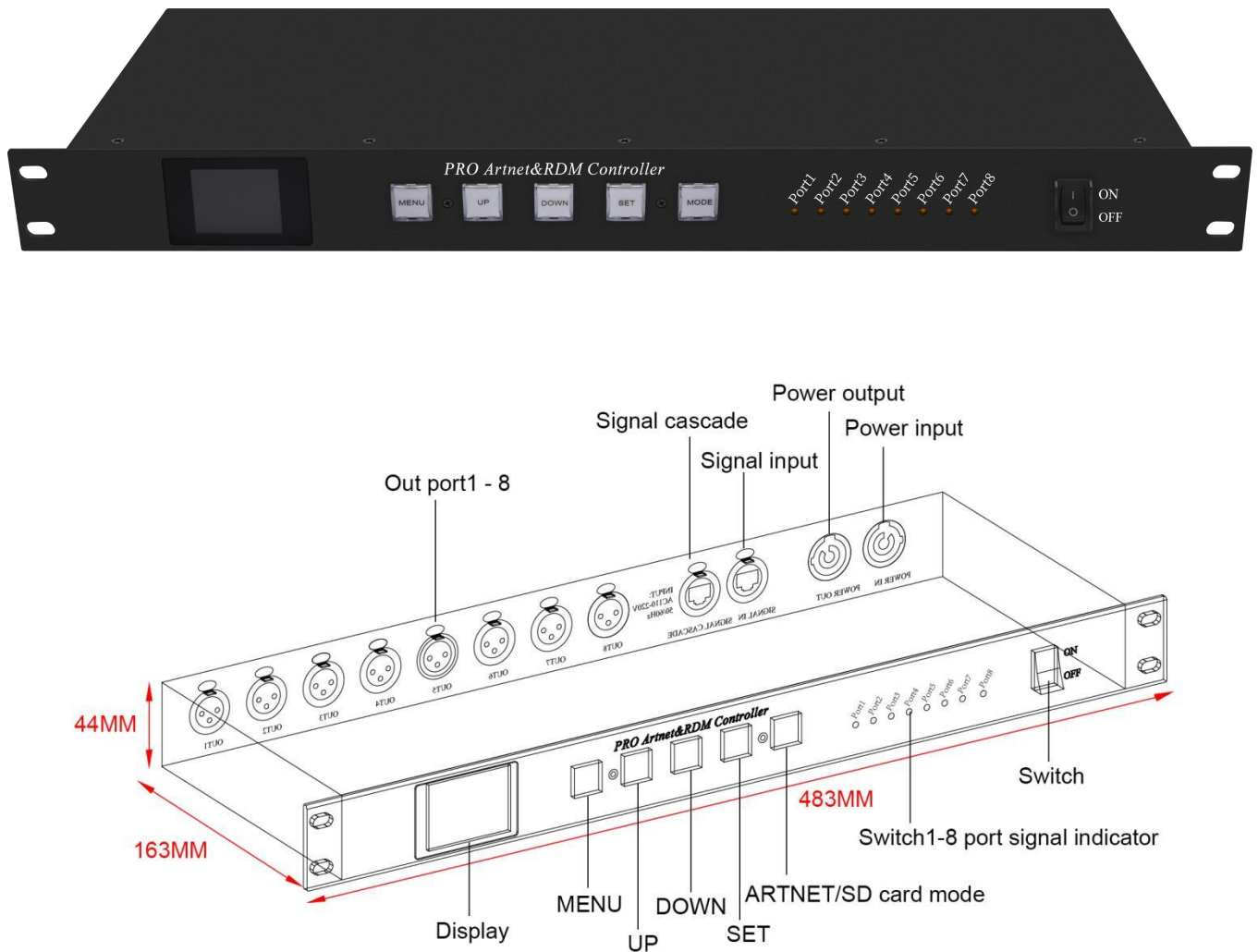



◆ **Product features:**

- 1. DMX channel expander, can be expanded to 8 DMX 512, total 4096 channels or SPI 5440 pixel;
- 2. Support multiple serial expansion channels, up to 32;
- 3. Output SPI to 485 signal, with a transmission distance of up to 200m;
- 4. High-speed switch-based Ethernet I/O for latency-free connections;
- 5. Three control modes, ARTNET、DMX and sACN mode;
- 6. Support ArtNet, DMX512, RDM protocol;
- 7. Support expansion of DMX output ports of Tiger Touch, GrandMA and other consoles;
- 8. All DMX ports are equipped with 3-pin Neutrik XLR (can be customized 5-pin);
- 9. 100% electrical isolation between all input/output ports: a problem on 1 port will not affect other ports;
- 10. Applicable to 19 inch cabinet 1U;
- 11. Support software: Mad-show, Madrix, Mad-mapper, Resolume;
- 12. Support effect recording and offline playback;

◆ **Parameter list**

Parameter	Unit	Min	Typical	Max
Working voltage(AC)	V	110	220	—
Power	W	—	—	5W
Output port	PCS	—	8	—
Port loading pixels	PIX	8*170	—	8*680
Control IC mode	—	—	WS2811/SK6812/UCS1903/UCS8903 /UCS9812/ DMX512	—
Supporting software	—	—	MAD-SHOW (MADRIX/RESOLUME/MAD-MAPPER)	—
Control mode	—	—	ART-NET/DMX/sACN	—
Working mode	—	—	ART-NET/SD card	—
Controller IP address	—	—	2.0.0.X	—
Subnet mask	—	—	255.0.0.0	—
Computer IP address	—	—	2.0.0.2	—
Number of cascade units	PCS	—	—	32
Product weight	KG	—	1.8	—
Product size(L*W*H)	MM	—	483*163*44	—
Product color	—	—	Matt silver+black	—
Product material	—	—	Aluminum	—



◆ Connection

① Connect controller input port

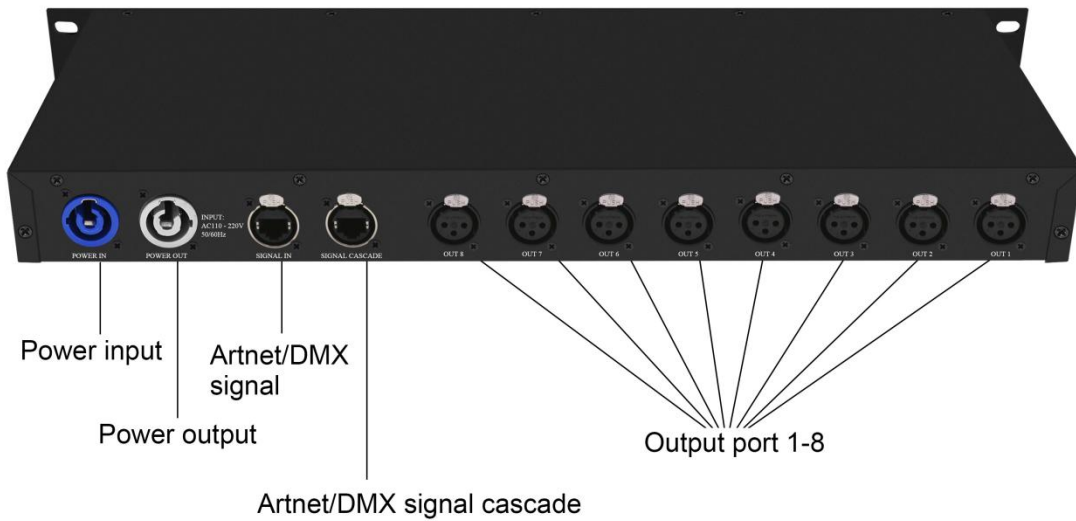
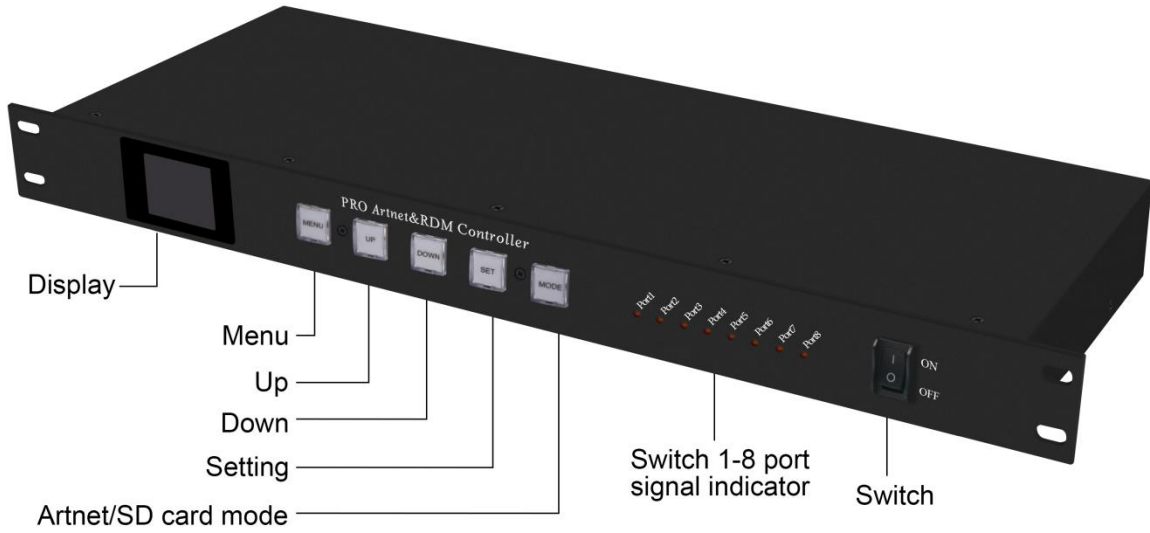



②ARTNET mode connect controller



Connect the output port of the controller and the input port of the light strip. (red cable is positive, black cable is negative, and white cable is signal); Connect the GND of controller and power supply together.

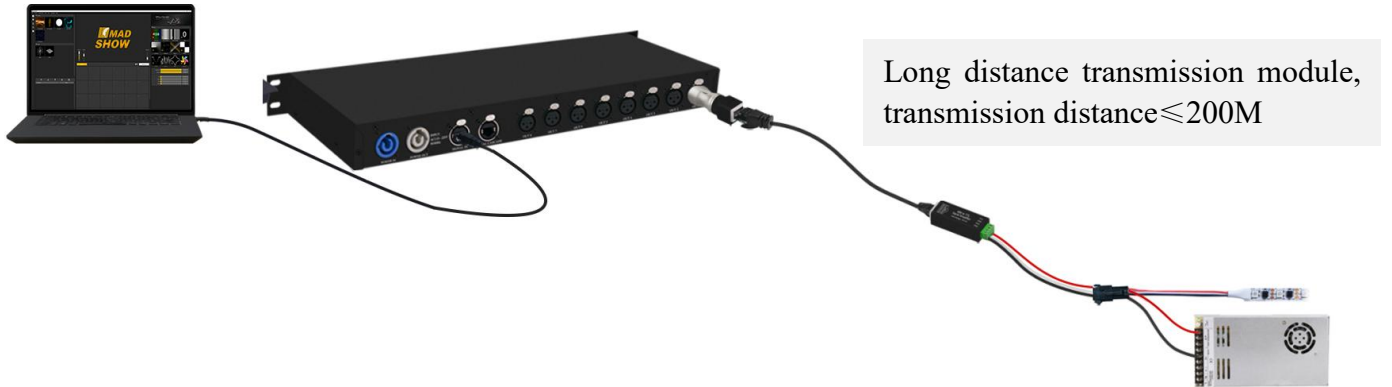

③DMX mode connect controller

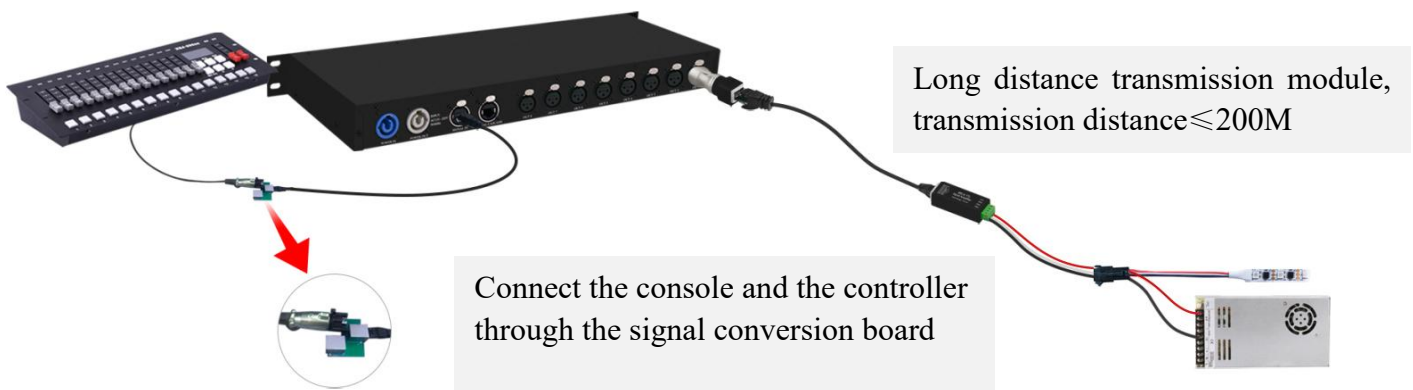

Connect the console and the controller through the signal conversion board

External power supply to supply power to the light strip (red cable is positive and black cable is negative)



◆ Multiple units can be used in cascade



Connect the output port with the input port of the next controller through network cable.

Note: When multiple controllers are cascaded, each controller IP setting cannot be the same!

◆ Control mode

After the controller is powered on, the red mark on the right side of the display indicates that there is no signal access; When the signal is connected, the signal mark is green, indicating that there is ARTNET signal access;

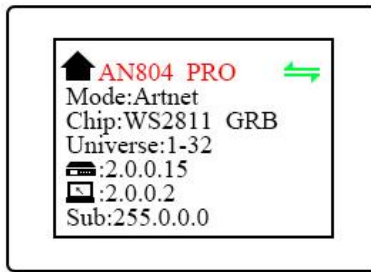
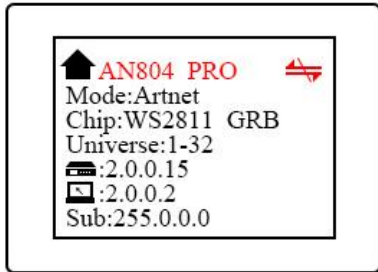

Mode switch

Short press the MODE button to enter the mode switching interface, click and press the MODE button to switch the mode,

Long press the button to exit the mode selection interface;

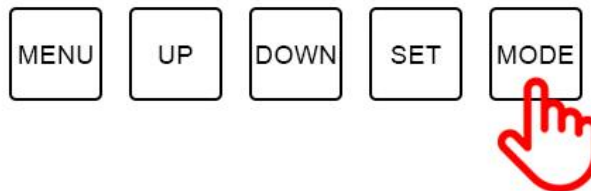
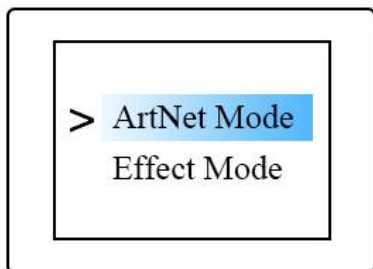



ARTNET mode

Short press the MENU button to enter the menu bar

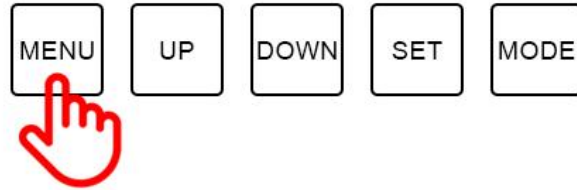
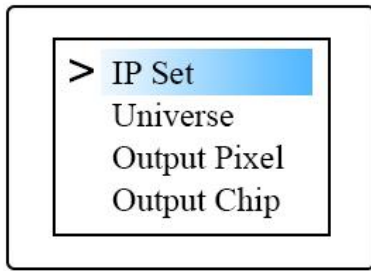

Short press the MENU button to enter the menu bar , Click the UP DOWN button to toggle the options;

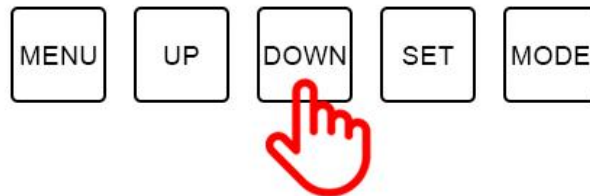
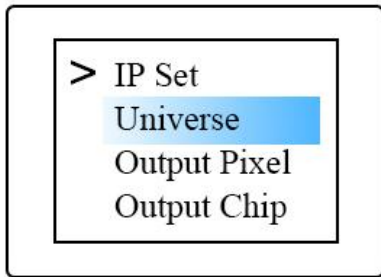

Click the SET button to enter the options, you can modify the option parameters. Click "SET" again to save, and long press "MENU" to return to the initial interface. The output of the controller port is an independent port output, and the port can carry a maximum of 680 pixels;

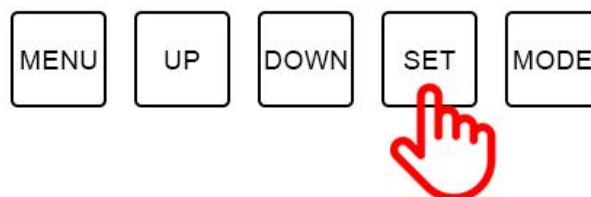
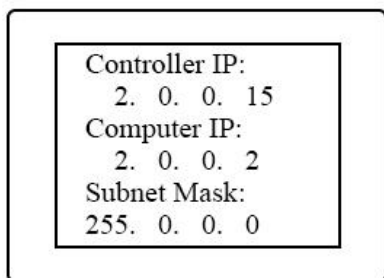

In the same way, parameter settings such as universe, channel, IC, and language can be modified;



Built-in effect mode

Click "UP" and "Down" to switch the effect, click "MENU" or "SET" to switch the speed; there are 31 built-in effects to choose from;

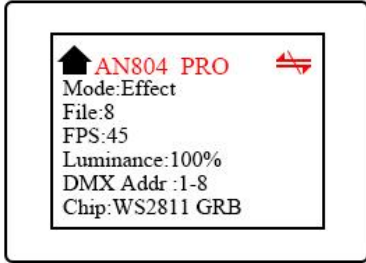

Short press the MENU button to enter the menu bar,

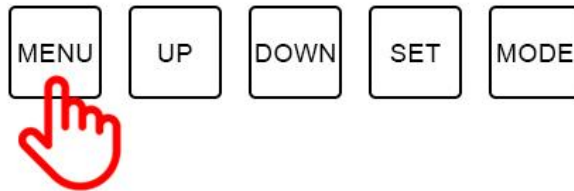
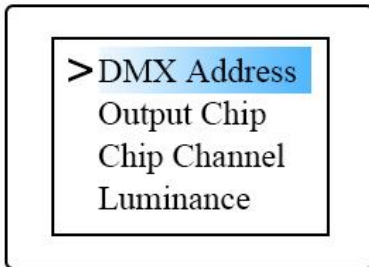

Click the SET button to enter the options, you can modify the option parameters. Click "SET" again to save, and long press "MENU" to return to the initial interface.

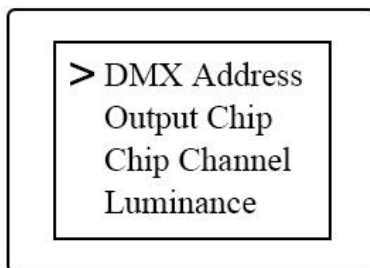
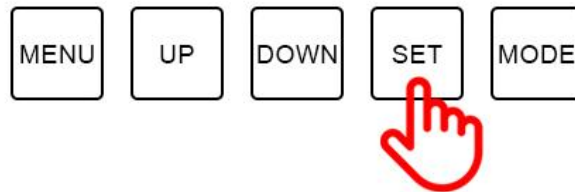
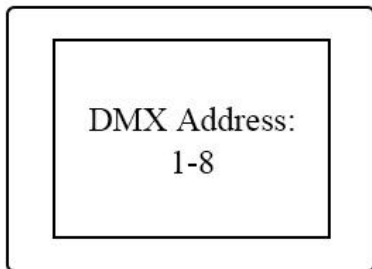

In the same way, parameter settings such as universe, channel, IC, and language can be modified;



DMX Channel Table Description

Channel	Name	Figure	Instructions
1	Mode selection	000-247	Call internal 31 effects (one effect for every 8 addresses, and 0-7 for SD card effect 1)
		248-255	Switch to ART_NET mode
2	Speed	000-255	0 is the slowest speed, 255 is the fastest speed, SD card mode is valid
3	Brightness	000-255	0 is the brightness off, 255 is the brightest, SD card mode is valid
4	R- mask	000-255	Subtract red from the effect. 000 is the original effect, and 255 means subtract all red from the effect
5	G-mask	000-255	Subtract green from the effect. 000 is the original effect, and 255 is subtracting all green from the effect
6	B-mask	000-255	Subtract the blue in the effect. 000 is the original effect. 255 means subtract all the blue in the effect
7	Invalid	000-007	
	Normally on	008-015	Constant bright white, color selection by mask (brightness, mask channel available)
	stroboscopic	016-255	The higher the value, the faster the strobe (speed, brightness, mask channel is effective)
8	Invalid	000-200	
	Record	201-255	When the value of channel 4.5.6 is 255, the recording is valid and the ART_NET effect is recorded to the file specified by channel 1



◆ Application

1. Stage performance;
2. The site of the product/press conference;
3. Concert lighting control;
4. Bar and KTV lighting control;



◆ Attention

1. Pay attention to the use environment and be waterproof and moisture-proof;
2. This controller needs an external power supply, please note that the output voltage of the power supply is consistent with the input voltage of the lamp;
3. Please follow the above instructions when connecting to an external power supply;
4. If any abnormality is found during use, contact us in time;